

ENERGIZER EN529

USA Construction

6V



Industry Standard Dimensions

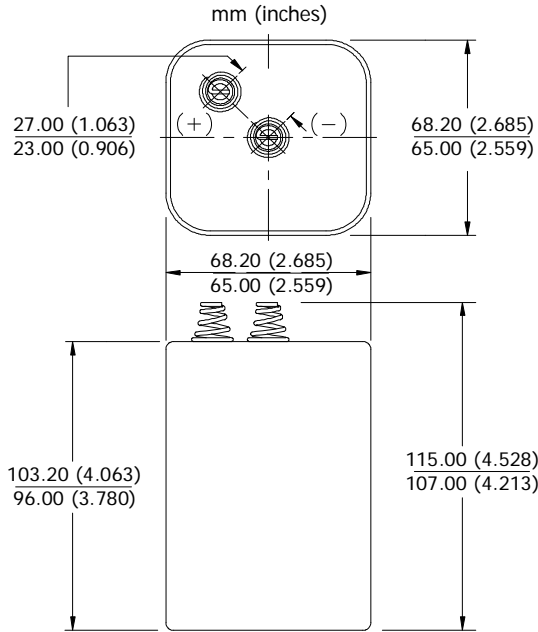

This battery shall pass freely through a cylindrical tube 82.6 diameter x 101.6 long.

Specifications

NOT INTENDED FOR RETAIL TRADE

Classification:	Alkaline
Chemical System:	Zinc-Manganese Dioxide (Zn/MnO ₂) No added mercury or cadmium
Designation:	ANSI-908A
Nominal Voltage:	6.0 volts
Operating Temp:	-18°C to 55°C (0°F to 130°F)
Typical Weight:	665 grams (23.5 oz.)
Typical Volume:	440.4 cubic centimeters (26.9 cubic inch)
Jacket:	Metal
Cells:	Four 3-350 in series
Terminal:	Coil Spring

Milliamp-Hours Capacity

Continuous discharge to 3.2 volts at 21°C

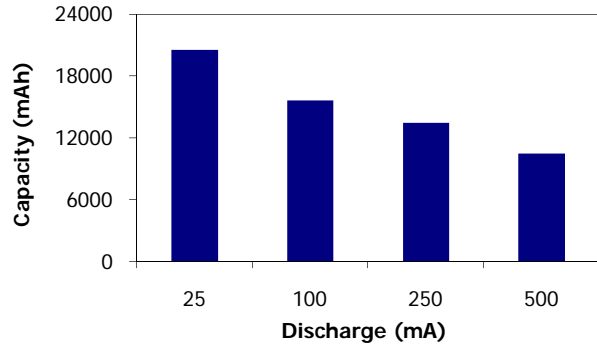

Constant Resistance Performance

Typical Characteristics (21°C)

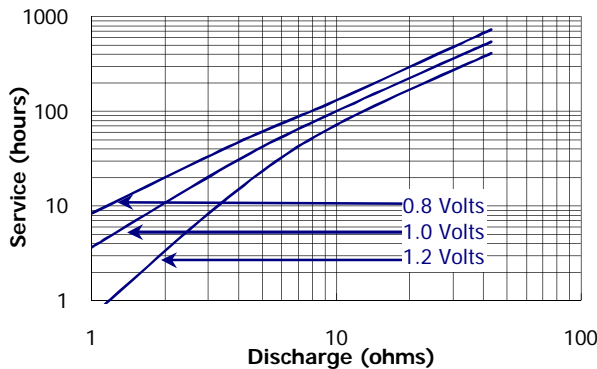

Constant Current Performance

Typical Characteristics (21°C)

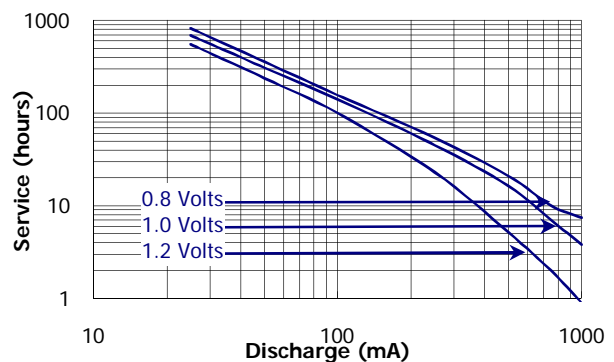

Important Notice

This data sheet contains typical information specific to products manufactured at the time of its publication.
©Energizer Holdings, Inc. - Contents herein do not constitute a warranty.

ENERGIZER EN529

6V

Industry Standard Tests (21°C)

STEADY BURN BARRICADE
110 ohm 12 hrs/day

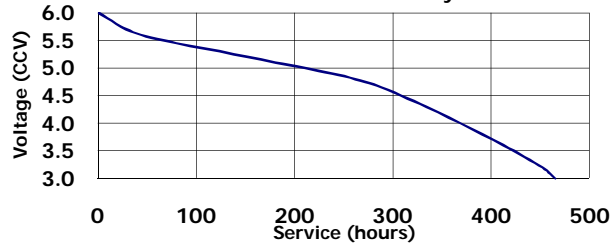

LIGHTING
9.1 ohm 30 min/hour 8 hrs/day

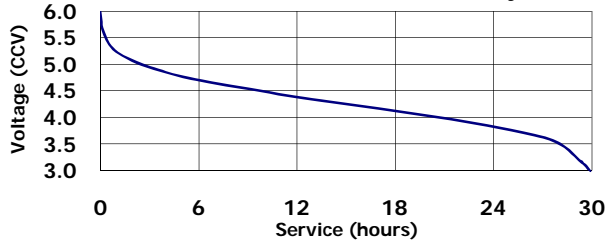

LIGHTING
33 ohm 30 min/hour 8 hrs/day

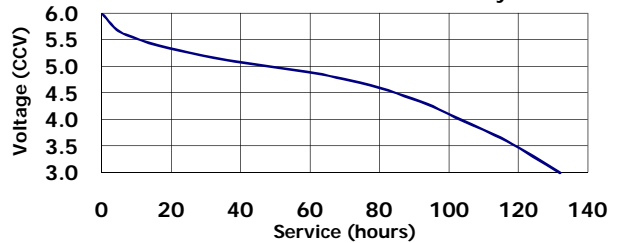

Important Notice

This data sheet contains typical information specific to products manufactured at the time of its publication.
© Energizer Holdings, Inc. - Contents herein do not constitute a warranty.